

cevisama.com

#Cevisama25

#CEVISAMACONNECTIONS

# CEVISAMA

International Ceramics & Bathroom Experience

24 - 28 FEB  
VALÈNCIA - SPAIN

Guía / Guide

**Fechas · Dates**

Del 24 al 28 de febrero 2025  
From 24<sup>th</sup> to 26<sup>th</sup> February 2025

**Horario · Schedule**

24 - 27 Feb de 9:00 a 18:00h  
24<sup>th</sup> - 27<sup>th</sup> Feb from 9:00 am to 6:00 pm

28 Feb de 9:00 a 15:00h  
28<sup>th</sup> Feb from 9:00 am to 3:00pm

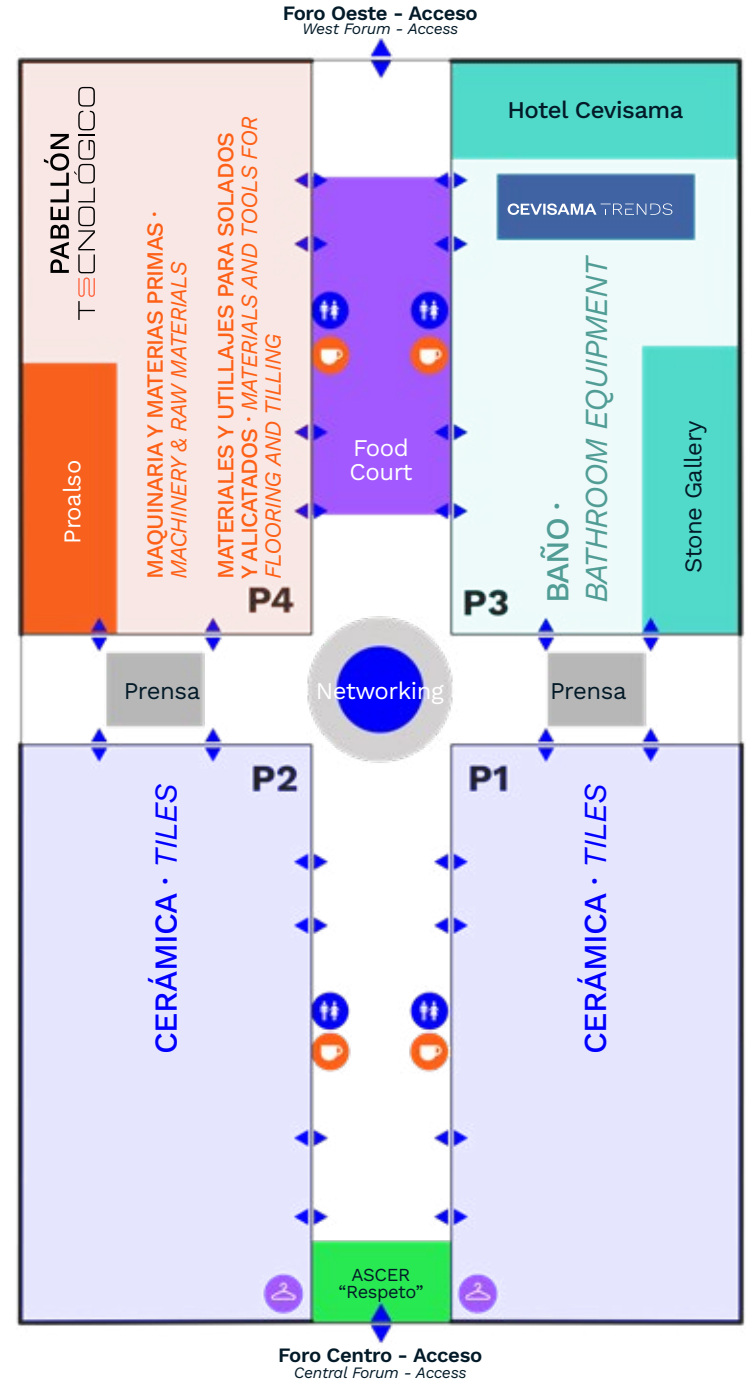
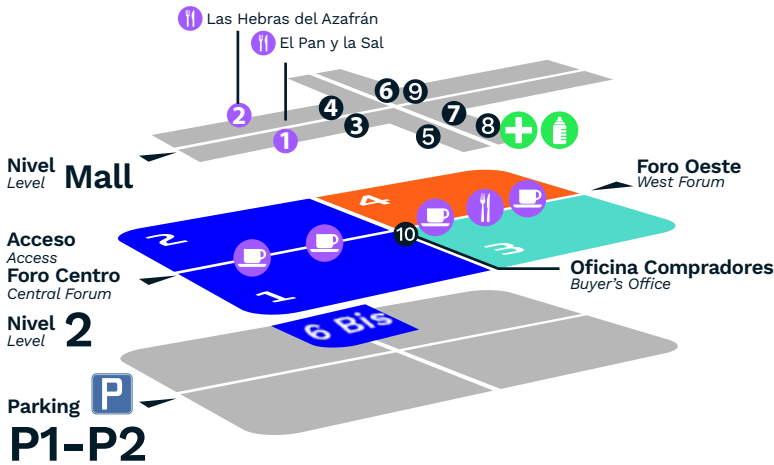

# LISTADO GENERAL DE LA FERIA (A-Z)

General List of the Fair (A-Z)

## Expositores - Marcas

Exhibitors - Brands

(Orden alfabético / Alphabetical order)



Expositor / Exhibitor  
Marca / Brand

Pab.  
Pav.



0-9		P4	A18
A	7C TOOLS	P2	A33
	AF INFORMÁTICA APLICADA	P3	C61
	AIDIMME	P4	E4
	AKEMI SPAIN	P2	B28
	ALAPLANA SL	P2	D22
	ALELUÍA CERAMICS	P4	B54
	ALIPLAST IBERIA SLU	P2	D80
	ALTERET CERÁMICAS	P2	A22
	ALTTGLASS GROUP	P2	A53
	AMADIS FINE TILES SA	P4	A63
	AMBERGER KAOLINWERKE	P3	ST10
	AMORÓS & COLLADO NATURAL STONE SL	P4	D7
	ANERR	P1	A5
	ANTICA CERÁMICA RUBIERA	P2	B79
	ANTICFANG SL	P3	CT14
	ANTIGA	P1	B22
	APARICI	P1	B24
	APAVISA	P1	A28
	APEGRUPO	P1	B32
	ARCANA	P4	B16
	ARMADA GROUPE INSAAT TURIZM GIDA SAN.	P1	D76
	ARTISTICA 3	P4	D5
	ARTTROS LEVELING SYSTEMS	DIST	T4
	ASCER	P3	C60
	ASD BATH	P3	C61
	ASEBAN	P4	B59
	ASEBEC / ITC	P3	A15
	ASM TAPS SA	DIST	9
	ASOC. ESP. TÉCNICOS CERÁMICOS (ATC)	P4	A41
	ASOC. FABRICANTES DE LADRILLOS Y TEJAS CV	P2	B66
	AZULEJOS EL MIJARES SL	P1	B79
	AZULFER SA	P3	D40
B	BARIPERFIL SL	P4	B55
	BARRAGANES GRUPO	P3	ST9
	BATEIG PIEDRA NATURAL SA	P3	B61
	BECRISA 2011 SL	P2	D18
	BORA CELIK LDT. STI.	P4	E48
C	C.S.H. CABANES SL	DIST	T1
	CÁMARA DE COMERCIAL DE CASTELLÓN-QUALICER		

## Expositores - Marcas

Exhibitors - Brands



Expositor / Exhibitor  
Marca / Brand

Pab.  
Pav.



C	CAMÍ DEPURAZIONI GREEN TECHNOLOGY SRL	P4	A41
	CASSICA BATHS	P3	C1
	CERAGNI GROUP	P1	A33
	CERÁMICA RIBESALBES SA	P2	D26
	CERÁMICA VILAR ÁLBARO SL	P2	B23
	CERÁMICAS MIMAS SL	P1	D24
	CERLAT SA	P2	C65
	CERPA CERÁMICA	P2	B42
	CERTECH SPAIN SL	P4	B57
	CEVICA	P1	A37
	CEVISAMA TRENDS	P3	
	CIC CONSTRUCCIÓN	DIST	6
	CICOGRES	P2	B8
	CIPASI	P4	B45
	COAC VALENCIA	DIST	AC1
	COLEGIO OF. DISEÑADORES DE INTERIOR	P3	D68
	CONSTRUIR	DIST	2
	CORBARIO MINERAIS INDUSTRIAIS SA	P4	E54
	CORTAG INDUSTRIA E COMERCIO LTDA	P4	A28
	COTTO PETRUS	P1	A5
	COYCAMA	P3	B61
	CRÉDITO Y CAUCIÓN	P4	A27
	CRISTACER (CRISTAL CERÁMICAS SA)	P1	A70
	CTAV - COLEGIO TERRITORIAL ARQUITECTOS VALENCIA	P3	D66
D	DA VINCI CERÁMICA	P2	B69
	DACHSER	P4	B52
	DADE BUILDING MATERIALS	P1	A73
	DADO CERÁMICA SRL	P1	A5
	DAKOTA	P4	B18
	DAL PRETE	P4	E46
	DANIEL RUBINETTERIE	P3	CT10
	DAS TECH SOLUTIONS SLU	P4	D49
	DECOCER	P1	A51
	DECOSAN	P3	D31
	DIPUTACIÓN PROVINCIAL DE CASTELLÓN	P2	T2
	DONATONI MACCHINE	P4	D53
	DREVEX CERAMICS SL	P2	D16
	DROP MARTINIDIS SA	P3	D38
E	EDICIONES CASTELLÓN PLAZA 2018 SL	DIST	4

## Expositores - Marcas

Exhibitors - Brands



Expositor / Exhibitor  
Marca / Brand

Pab.  
Pav.



E	EDPLIT	P3	D2'
	EL CORTE INGLÉS SA	DIST	EC11
	EL MOLINO CERÁMICS	P1	B45
	EMAC	P2	A70
	EMBEPLAST SLU	P2	D81
	EMCO SPAIN	P4	D6
	EMIGRES	P2	B18
	EMOTION CERAMICS	P2	B8
	ENERGIEKER	P1	D16
	EPICENTR CERAMIC CORPORATION	P2	D38
	EQUIDIS EUROPA SL	P3	A1
	EQUIPE CERÁMICAS SL	P2	B4
	ETERNO IVICA	P4	A18
	EUROBATH FACTORY SPAIN SLU	P3	D37
	EXAGRES	P1	B57
	EXCO - SALÓN TECNOLÓGICO DE LA CONSTRUCCIÓN	DIST	5
F	FABER IBERIA SL	P4	D9
	FABISTONE LDA	P2	A51
	FABRESA	P1	B49
	FERRARI & CIGARINI SRL	P4	D45
	FILA - SURFACE CARE SOLUTIONS	P4	D23
	FORANKRA ESPAÑA	P4	A64
	FORO	P4	B56
	FUSTECMA	P2	D24
G	GAYAFORES	P2	B41
	GB GROUP SRL	P3	D15
	GENEXIA	P3	B2
	GHELFI SRL	P4	B4
	GME DIVISIÓN BAÑOS SL	P3	A28
	GOCCIA EUROPE SPAS SL	P3	B67
	GRES ARAGÓN	P2	B15
	GRIFERÍAS BORRÁS SL	P3	A7
	GRIFERÍAS NOVA SL	P2	D24
	GRUPO COGULLADA	P4	B51
	GRUPO SEYS MUEBLES	P3	B36
	GUNSEN BUILDING PRODUCTS	P4	D15
H	HÁBITAT	DIST	HA
	HALCÓN CERÁMICAS SLU	P2	B8
	HARMONY	P1	B42

## Expositores - Marcas

Exhibitors - Brands



Expositor / Exhibitor  
Marca / Brand

Pab.  
Pav.



H	HIDRONATUR BY PLASVINA	P3	B59
	HISPABAÑO	P3	B38
	HOPEN SANITARY WARE	P3	A49
	HOSOKAWA ALPINE GROUP	P4	B45'
I	IBERICA MARBLE & GRANITE CORPORATION SL	P3	ST2
	IBERO	P6BIS	A1
	IBEROSTONE	P3	ST4
	IBERTRONIX INFRARED & VISION SL	P4	B46'
	ICF & WELKO SPA	P4	B48
	IDRO-BRIC	P3	A29
	INDUSTRIAS PEYGRAN SL	P4	B23
	INFOEDITA COMUNICACIÓN PROFESIONAL SL	DIST	8
	INGENEO EQUIPOS INDUSTRIALES SL	P4	B50
	INKOART SOLUCIONES SL	P3	A45
	INPEDRA SLU - NATURAL STONE SOLUTIONS	P3	ST5
	INSCA	P1	C80
	INSTITUTO DE TECNOLOGÍA CERÁMICA-ITC	DIST	T1'
		P4	B59
	INTEGRA SOLUTIONS	P3	CT13
	INTEREMPRESAS MEDIA	DIST	16
	INTERGLOBO	P4	A65
	INTERMATEX SL	P1	D18
	INTHETILE	P1	A27
	IRIDOI	P4	B6
	IRSAP IBÉRICA	P3	CT2
	IVACE - INSTITUTO VALENCIANO DE CERÁMICA	DIST	IV1
	IZOMAK YAPI ALUMINIUM AND STAINLESS	P4	A17
J	JOBASAN IMPORT EXPORT SL	P2	A9
	JOBERS Y ASOCIADOS SL	P1	A41
	JVREPRESENTAÇÕES - JORGE M.D. VIRGILIO	P3	D5
K	KAIROS MEDIA GROUP SRL	DIST	12
	KERABEN	P6BIS	A1
	KERABEN GRUPO	P6BIS	A1
	KERADOM	P1	A35
	KTL CERÁMICA SL	P1	B58
L	LA FENICE SRL	P2	B54
	LEICA GEOSYSTEMS PART OF HEXAGON	P4	C3
	LIFE CERÁMICA	P3	CT8
	LITICA INNOVACION SL	P2	D46

## Expositores - Marcas

Exhibitors - Brands



Expositor / Exhibitor  
Marca / Brand

Pab.  
Pav.



L	LOVEX SANITARY WARE	P3	A33
	M	MAINZER SL	P4
M	MAINZU	P2	B53
	MANILLONS TORRENT	P3	A16
	MANUFACTURAS PORTA CELI	P3	D44
	MAPEI	P4	D41
	MÁRMOLES EMEREX	P3	ST3
	MÁRMOLES NEI	P3	ST12
	MÁRMOLES VISEMAR	P3	ST11
	MAROCCHI SRL	P2	A65
	MARTI 1921	P3	A47
	MAYOLICA AZULEJOS SL	P2	D55
	MCS PORTUGAL	P4	E44
	MEDEXMAR	P3	ST8
	MEDITERRÁNEO	DIST	18
	METROPOL	P6BIS	A1
	MG VALENCIA	P3	D42
	MGM CERAMICHE	P1	A30
	MIKONOS CERAMICA	P1	D50
	MIRTAK SL	P3	B65
	MOLDE AZUL	P4	D51
	MONOPOLE	P1	D58
	MONOTILE TRADING SRL	P2	A55
	MONTOLIT HERRAMIENTAS PROFESIONALES	P4	B26
	MOSAVIT	P2	B51
MUEBLES JUMAR SL	P3	D28	
MUSEUM	P1	B42	
N	NANDA TILES SL	P1	A54
	NA-NUEVO AZULEJO/ TÉCNICA CERÁMICA WORLD	DIST	10
	NATUCER	P1	B70
	NATURAL COMFORT	P3	CT7
	NAXANI DESIGN SL	P3	B51
	NEO VALLS	P3	CT12
	NEW TILES	P2	D58
	NOBILI	P3	CT9
	NOFER	P3	D31
	NOGOSA IBERICA SLU	P4	B7
	NOLTIA SYSTEM	P3	D52
NUOVOCORSO S.P.A.	P1	D76	

## Expositores - Marcas

Exhibitors - Brands

 Expositor / Exhibitor  
Marca / Brand

**Pab.**   
*Pav.*

O	ODEM	P4	B5
	ONIX	P1	A32
P	PANEL AREA	P1	A15
	PEMAX	P3	A5
	PERONDA GROUP SA	P1	B42
	PLASDECOR CASTELLÓN SL	P1	D78
	POALGI SL	P3	D21
	PORCELÁNICOS HDC SA	P2	D65
	PORTCASTELLÓ	P4	E56
	PRACTIKA CERÁMICA	P2	D28
	PROALSO, ASOC. PROF. ALICATADORES	P4	E30
	PRODIM INTERNATIONAL BV	P4	B46
	PROFILBER	P4	B1
	PROFILITEC	P4	B2
	PRUSSIANI ENGINEERING	P4	B44
	PURE CERAMICS SL	P2	D48
	Q	QASAR CERAM	P2
QUICK GRES		P3	CT4
R	RAIMONDI S.P.A.	P4	A9
	RAMON SOLER	P3	B30
	REALONDA SA	P2	B37
	REMER RUBINETTERIE SPA	P3	CT6
	RESACRIL SL	P4	A63
	RESIPLAT VEGA BAJA SL	P3	CT11
	REVISTE	P3	D7
	ROCAS ARAM SL	P3	ST7
	ROCED	P3	CT3
	ROOM ART	P3	A51
	RUBI GROUP	P4	D31
	RUBICER LDA	P3	B24
S	SACMI	P4	E40
	SALA BAÑO REVISTA	DIST	1
	SANTISHOWER	P3	A57
	SAVINO DEL BENE SL	P4	A44
	SELF STYLE	P1	A35
	SIGMADIAMANT SL	P4	E42
	SOCIEDAD ESPAÑOLA DE CERÁMICA Y VIDRIO	DIST	3
	SONIA SA	P3	CT1
	SPANISH MARBLE GROUP	P3	ST1

## Expositores - Marcas

Exhibitors - Brands

 Expositor / Exhibitor  
Marca / Brand

**Pab.**   
*Pav.*

S	SPARK VISION AB	P1	A25	
	SQUAMERS MOSAIC SL	P1	A13	
	STN CERÁMICA	P1	A10	
	STONE BASIQ SL	P3	ST6	
	SUIMCO	P4	A18	
	SUPERCERÁMICA	P2	B67	
	SWISSPOR BOARD	P4	A35	
	T	TERRATINTA GROUP	P1	D42
		TERZADIMENSIONE	P2	A61
		TESAY BU PROFIL SISTEMLERI SAN.VE TIC.LT	P2	A15
THIELMANN PORTINOX SPAIN SA		P3	CT5	
TIZIRI CERAMICA		P2	A2	
TOGAMA MORE THAN MOSAIC		P2	D70	
TOMECANIC - CONSTOOLS		P4	B30	
TU REFORMA		DIST	7	
TRIP ESTILO SLU		P2	B51	
U		UNDEFASA SA	P1	B23
	UNICOMSTARKER	P1	D28	
	UNITILES	P2	D72	
V	VALENPLAS SLU	P1	A23	
	VALMAN MOBILIARIO	P3	A19	
	VANITA DOCCE SRL	P3	B4	
	VERNIPRENS SA	P3	A4	
	VITACER	P2	B70	
	VIVES	P1	B30	
	VOGO SPAIN	P3	A70	
W	WATEREVOLUTION	P3	D11	
Y	YCR	P1	A71	

# CEVISAMA

International Ceramics & Bathroom Experience

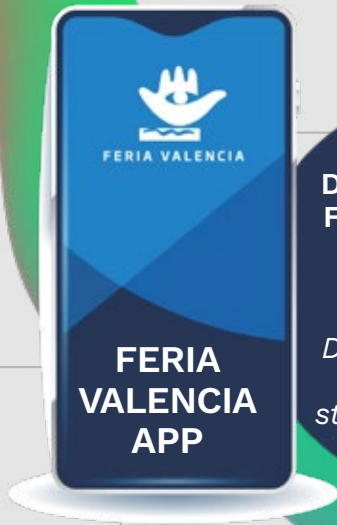

Descarga la APP de Feria Valencia para estar informado sobre #CVSM25.

*Download the Feria Valencia APP to stay informed about #CVSM25.*

Escanea el QR o haz clic en el botón  
*Scan the QR or click on the button*



**WIFI GRATIS**  
*FREE WIFI*

Red / Network:  
**FiraWifi**

Clave / Password:  
**freewifi**

# LISTADO DE EXPOSITORES *POR PABELLÓN*

*Exhibitors list by Pavilion*



# DISTRIBUIDOR

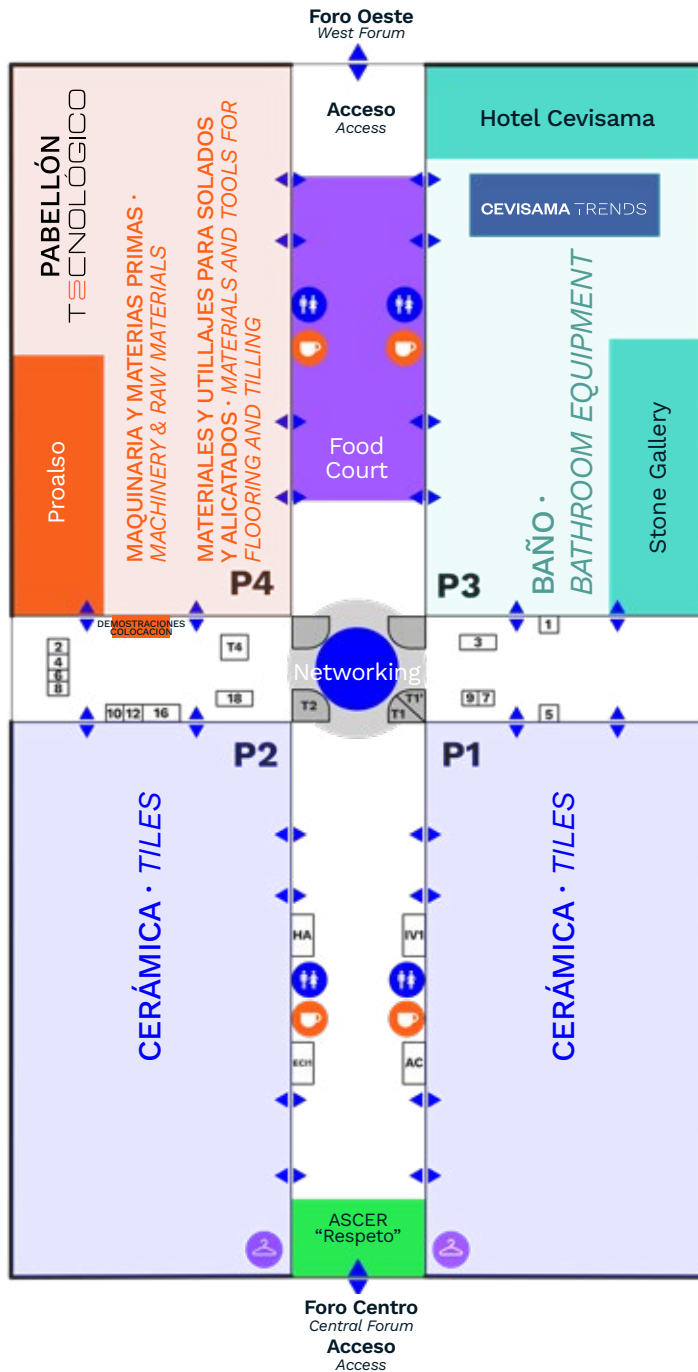
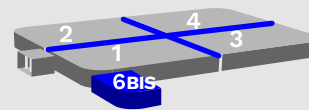

**Expositor / Exhibitor**  
Marca / Brand

**Pab. Pav.**



ASCER	DIST	T4
ASOCIACIÓN ESP. TÉCNICOS CERÁMICOS- ATC	DIST	9
CÁMARA DE COMERCIO CASTELLÓN -QUALICER	DIST	T1
CIC CONSTRUCCIÓN	DIST	6
COAC VALENCIA	DIST	AC1
COLEGIO OF. DE AGENTES COMERCIALES	DIST	AC1
CONSTRUIR	DIST	2
DIPUTACIÓN PROVINCIAL DE CASTELLÓN	DIST	T2
EDICIONES CASTELLÓN PLAZA 2018 SL	DIST	4
EL CORTE INGLÉS SA	DIST	EC11
EXCO - SALÓN TECNOLÓGICO DE CONSTRUCCIÓN	DIST	5
HÁBITAT	DIST	HA
INFOEDITA COMUNICACIÓN PROFESIONAL	DIST	8
INSTITUTO DE TECNOLOGÍA CERÁMICA - ITC	DIST	T1'
INTEREMPRESAS MEDIA	DIST	16
IVACE - INSTITUTO VALENCIANO DE CERÁMICA	DIST	IV1
KAIROS MEDIA GROUP SRL	DIST	12
MEDITERRÁNEO	DIST	18
NA-NUEVO AZULEJO/TÉCNICA CERÁMICA WORLD	DIST	10
SALA BAÑO REVISTA	DIST	1
SOCIEDAD ESPAÑOLA DE CERÁMICA Y VIDRIO	DIST	3
TU REFORMA	DIST	7

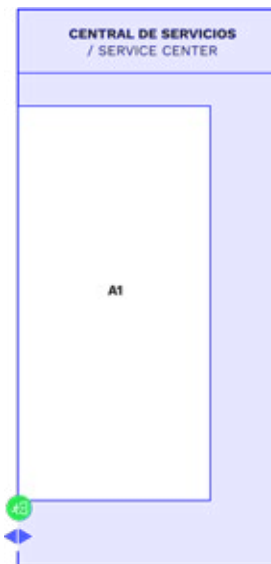

## PAB/PAV. 6 BIS

Foro Norte / North Forum

IBERO	P6BIS	A1
KERABEN	P6BIS	A1
KERABEN GRUPO	P6BIS	A1
METROPOL	P6BIS	A1

**Salón de actos**  
*Conference hall*  
**Sala Alicante**  
*Alicante room*  
**Sala Castellón**  
*Castellon room*  
**Sala Valencia**  
*Valencia room*



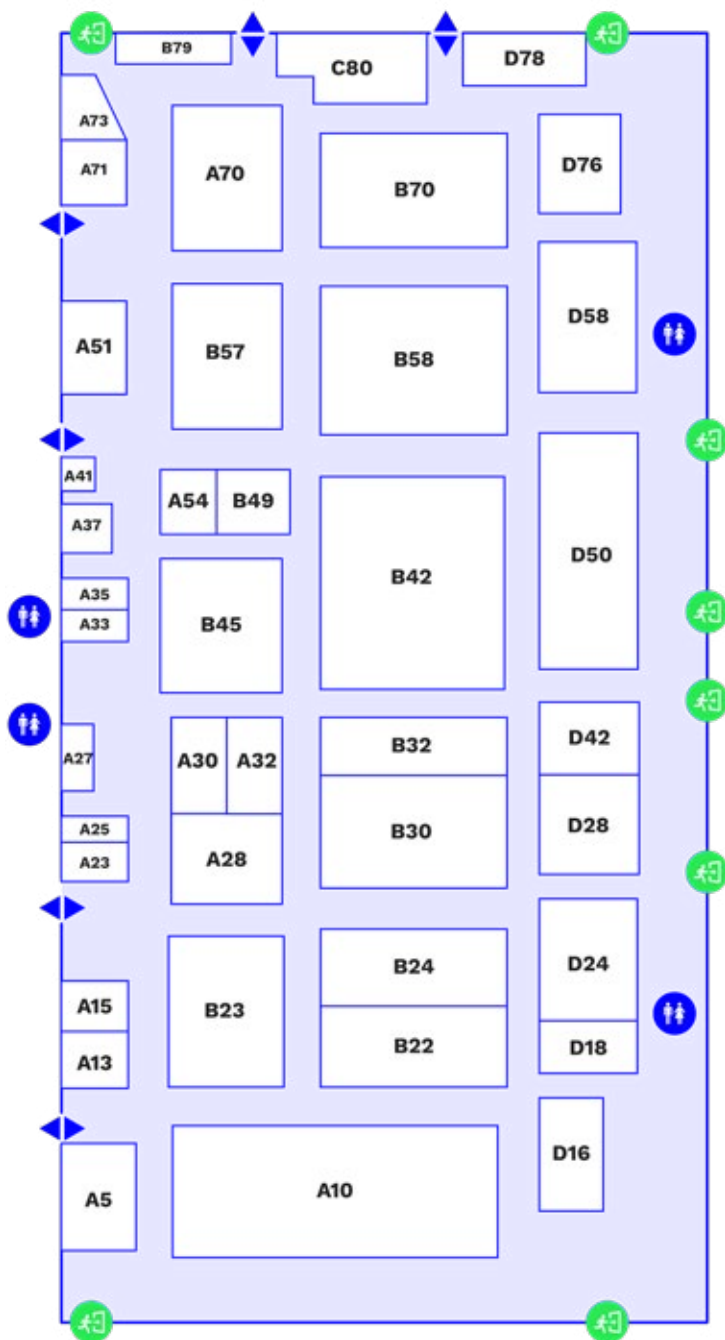
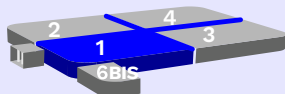

Expositor / Exhibitor  
Marca / Brand

Pab.  
Pav.



Expositor / Exhibitor Marca / Brand	Pab.	Pav.
ANTICA CERÁMICA RUBIERA	P1	A5
APARICI	P1	B22
APAVISA	P1	B24
APEGRUPO	P1	A28
ARCANA	P1	B32
ARTISTICA 3	P1	D76
AZULFER, S.A.	P1	B79
CERAGNI GROUP	P1	A33
CERAMICAS MIMAS, S.L.	P1	D24
CEVICA	P1	A37
COTTO PETRUS	P1	A5
CRISTACER (CRISTAL CERÁMICAS SA)	P1	A70
DADE BUILDING MATERIALS	P1	A73
DADO CERÁMICA SRL	P1	A5
DECOCER	P1	A51
EL MOLINO CERAMICS	P1	B45
ENERGIEKER	P1	D16
EXAGRES	P1	B57
FABRESA	P1	B49
HARMONY	P1	B42
INSCA	P1	C80
INTERMATEX SL	P1	D18
INTHETILE	P1	A27
JOBERS Y ASOCIADOS SL	P1	A41
KERADOM	P1	A35
KTL CERÁMICA, SL	P1	B58
MGM CERAMICHE	P1	A30
MIKONOS CERÁMICA	P1	D50
MONOPOLE	P1	D58
MUSEUM	P1	B42
NANDA TILES	P1	A54
NATUCER	P1	B70
NUOVOCORSO S.P.A.	P1	D76
ONIX	P1	A32
PANEL AREA	P1	A15
PERONDA GROUP SA	P1	B42



**Expositor / Exhibitor**  
Marca / Brand

**Pab.**  
Pav.



PLASDECOR CASTELLÓN SL	P1	D78
SELF STYLE	P1	A35
SPARK VISION AB	P1	A25
SQUAMERS MOSAIC SL	P1	A13
STN CERAMICA, SA	P1	A10
TERRATINTA GROUP	P1	D42
UNDEFASA SA	P1	B23
UNICOMSTARKER	P1	D28
VALENPLAS, SLU	P1	A23
VIVES	P1	B30
YCR	P1	A71



VISÍTANOS/ VISIT US  
N2 P1 STAND A10

[stnceramica.es](http://stnceramica.es)

**stn**  
CERÁMICA

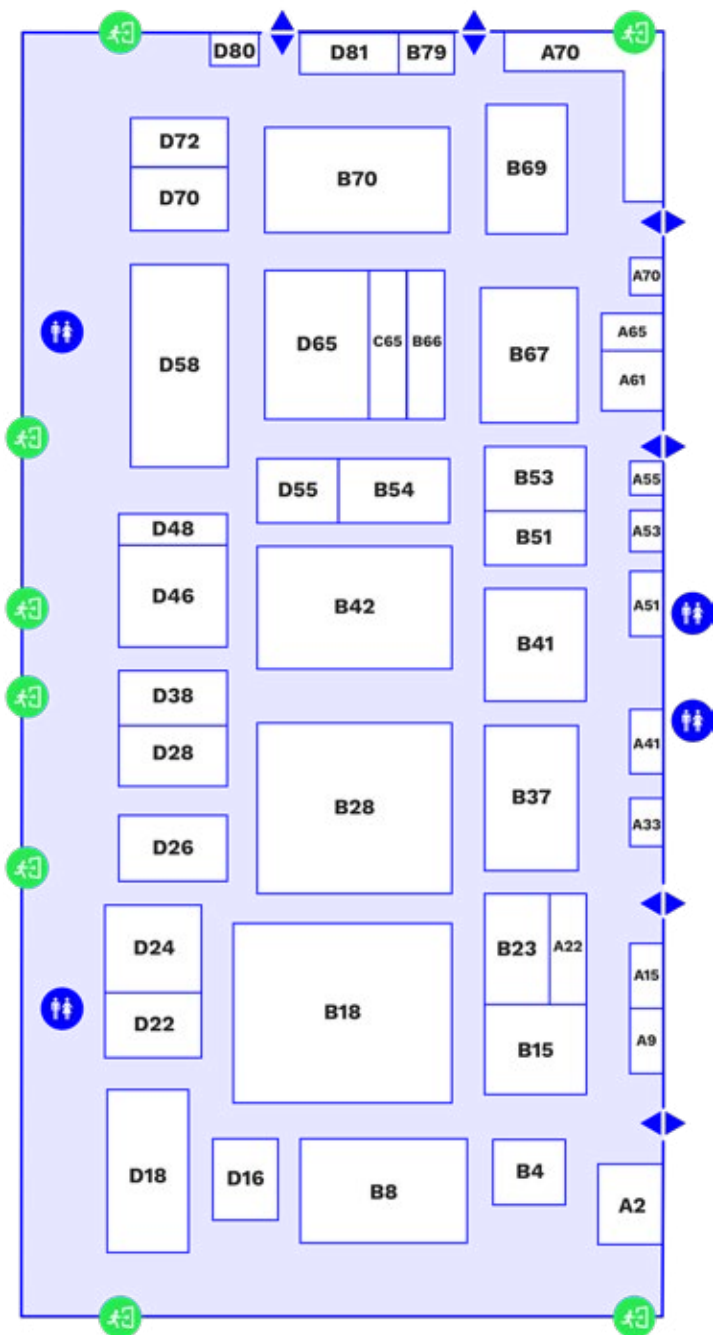
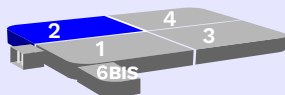

Expositor / Exhibitor  
Marca / Brand

Pab.  
Pav.



AF INFORMÁTICA APLICADA	P2	A33
ALAPLANA SL	P2	B28
ALELUIA CERAMICAS, S.A	P2	D22
ALTERET CERÁMICAS	P2	D80
ALTOGLASS GROUP	P2	A22
AMADIS FINE TILES SA	P2	A53
ANTICFANG, S.L.	P2	B79
AZULEJOS EL MIJARES, S.L.	P2	B66
BORA CELIK LTD STI	P2	D18
CERÁMICA RIBESALBES SA	P2	D26
CERÁMICA VILAR ÁLBARO, S.L.	P2	B23
CERLAT, S.A.	P2	C65
CERPA CERÁMICA	P2	B42
CICOGRES	P2	B8
DA VINCI CERÁMICA	P2	B69
DIPUTACIÓN PROVINCIAL DE CASTELLÓN	P2	T2
DREVEX CERAMICS SL	P2	D16
EMAC	P2	A70
EMBEPLAST SLU	P2	D81
EMIGRES	P2	B18
EMOTION CERAMICS	P2	B8
EPICENTR CERAMIC CORPORATION	P2	D38
EQUIPE CERÁMICAS	P2	B4
FABISTONE LDA	P2	A51
FUSTECMA	P2	D24
GAYAFORES	P2	B41
GRES ARAGÓN	P2	B15
GRIFERÍAS NOVA SL	P2	D24
HALCÓN CERÁMICAS	P2	B8
JOBASAN IMPORT EXPORT, S.L.	P2	A9
LA FENICE SRL	P2	B54
LITICA INNOVACIÓN SL	P2	D46
MAINZU	P2	B53
MAROCCHI SRL	P2	A65
MAYOLICA AZULEJOS SL	P2	D55
MONOTILE TRADING SRL	P2	A55



**Expositor / Exhibitor**  
Marca / Brand

**Pab.**  
Pav.



MOSAVIT	P2	B51
NEW TILES	P2	D58
PORCELÁNICOS HDC SA	P2	D65
PRACTIKA CERÁMICA	P2	D28
PURE CERAMICS SL	P2	D48
QASAR CERAM	P2	A41
REALONDA SA	P2	B37
SUPERCERÁMICA	P2	B67
TERZADIMENSIONE	P2	A61
TESAY BU PROFIL SISTEMLERI SAN.VE TIC.LT	P2	A15
TIZIRI CERAMICA	P2	A2
TOGAMA MORE THAN MOSAIC	P2	D70
TRIP ESTILO SLU	P2	B51
UNITILES	P2	D72
VITACER	P2	B70

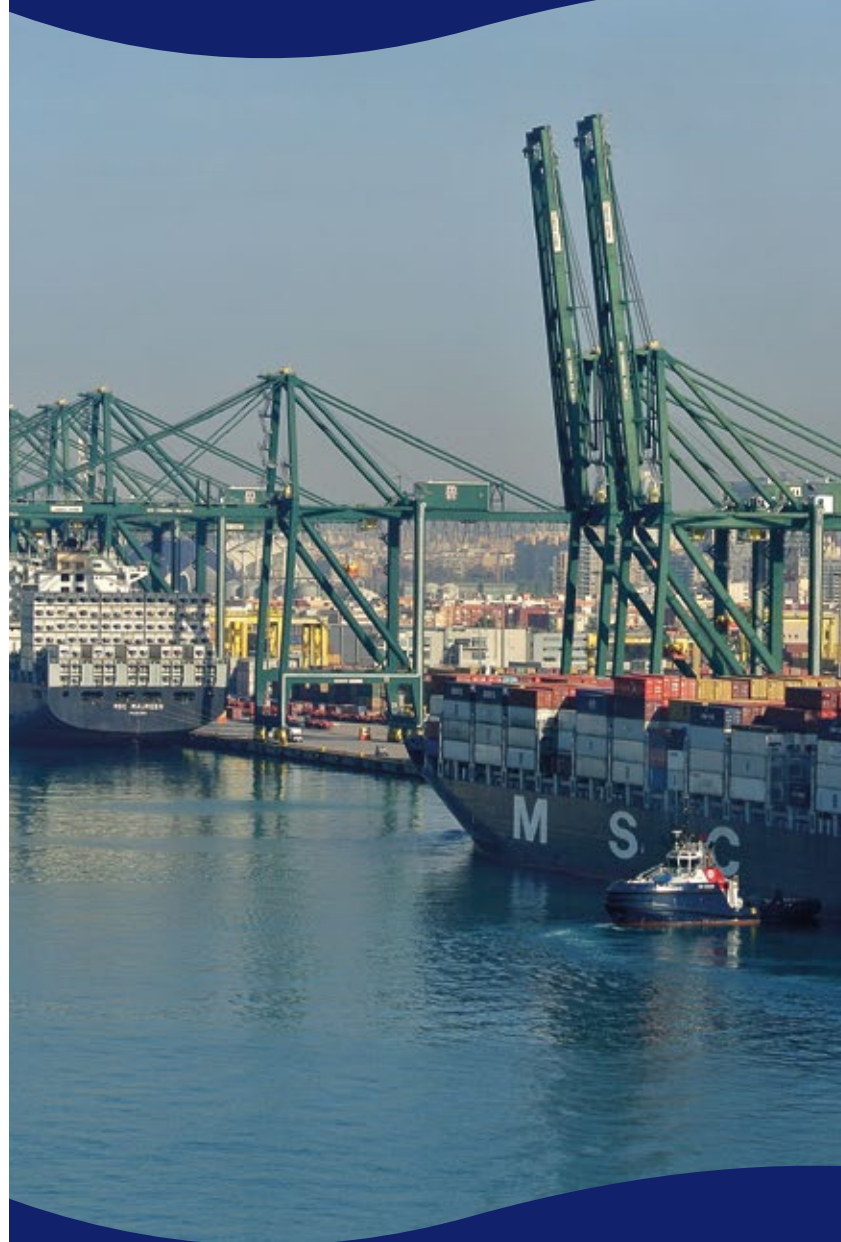

**Valenciaport, puerto de entrada y salida  
para los productos cerámicos en España**

*Valenciaport, serving foreign trade  
for ceramic products in Spain*

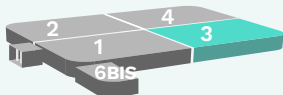

**Expositor / Exhibitor**  
**Marca / Brand**

**Pab.**  
**Pav.**



Expositor / Exhibitor Marca / Brand	Pab.	Pav.
AIDIMME	P3	C61
AMORÓS & COLLADO NATURAL STONE SL	P3	ST10
ANTIGA	P3	CT14
ASD BATH	P3	C60
ASEBAN	P3	C61
ASM TAPS SA	P3	A15
BARIPERFIL SL	P3	D40
BATEIG PIEDRA NATURAL SA	P3	ST9
BECRISA 2011 SL	P3	B61
CASSICA BATHS	P3	C1
CEVISAMA TRENDS	P3	
COLEGIO OFICIAL DE DISEÑADORES DE INTERIOR	P3	D66
COYCAMA	P3	B61
CTAV - COLEGIO DE ARQUITECTOS DE VALENCIA	P3	D66
DANIEL RUBINETTERIE	P3	CT10
DECOSAN	P3	D31
DROP MATINIDIS SA	P3	D38
EDPLIT	P3	D2'
EQUIDIS EUROPA SL	P3	A1
EUROBATH FACTORY SPAIN SLU	P3	D37
GB GROUP SRL	P3	D15
GENEXIA	P3	B2
GME DIVISION BAÑOS, S.L.	P3	A28
GOCCIA EUROPE SPAS SL	P3	B67
GRIFERÍAS BORRÁS	P3	A7
GRUPO SEYS MUEBLES	P3	B36
HIDRONATUR BY PLASVINA	P3	B59
HISPABAÑO	P3	B38
HOPEN SANITARY WARE	P3	A49
IBERICA MARBLE & GRANITE CORPORATION SL	P3	ST2
IBEROSTONE	P3	ST4
IDRO-BRIC	P3	A29
INKOART SOLUCIONES SL	P3	A45
INPEDRA SLU - NATURAL STONE SOLUTIONS	P3	ST5
INTEGRA SOLUTIONS	P3	CT13
IRSAP IBÉRICA SL	P3	CT2
JVREPRESENTAÇÕES - JORGE M.D. VIRGILIO	P3	D5



# PAB/PAV. 3

BAÑO · BATH  
HOTEL CEVISAMA  
STONE GALLERY  
CEVISAMA TRENDS



**Expositor / Exhibitor**  
Marca / Brand

**Pab.**  
Pav.



LIFE CERAMICA	P3	CT8
LOVEX SANITARY WARE	P3	A33
MANILLONS TORRENT	P3	A16
MANUFACTURAS PORTA CELI	P3	D44
MÁRMOLES EMEREX	P3	ST3
MÁRMOLES NEI	P3	ST12
MÁRMOLES VISEMAR	P3	ST11
MARTI 1921	P3	A47
MEDEXMAR	P3	ST8
MG VALENCIA	P3	D42
MIRTAK SL	P3	B65
MUEBLES JUMAR SL	P3	D28
NATURAL COMFORT	P3	CT7
NAXANI DESIGN SL	P3	B51
NEO VALLS	P3	CT12
NOBILI	P3	CT9
NOFER SL	P3	D31
NOLTIA SYSTEM	P3	D52
PEMAX	P3	A5
POALGI SL	P3	D21
QUICK GRES	P3	CT4
RAMON SOLER	P3	B30
REMER RUBINETTERIE SPA	P3	CT6
RESIPLAT VEGA BAJA SL	P3	CT11
REVISTE	P3	D7
ROCAS ARAM SL	P3	ST7
ROCED	P3	CT3
ROOM ART	P3	A51
RUBICER LDA	P3	B24
SANTISHOWER	P3	A57
SONIA SA	P3	CT1
SPANISH MARBLE GROUP	P3	ST1
STONE BASIQ SL	P3	ST6
THIELMANN PORTINOX SPAIN SA	P3	CT5
VALMAN MOBILIARIO	P3	A19
VANITA DOCCE SRL	P3	B4
VERNIPRENS SA	P3	A4
VOGO SPAIN	P3	A70
WATEREVOLUTION	P3	D11



**CASINO**  
CIRSA VALENCIA

## RESTAURANT

ONE Valencia Restaurant | *Non stop* gastronomy

## ENTERTAINMENT

Live music Tuesday to Saturday from 10PM to 1AM

## CASINO

Open 24/7



Free  
entry  
+ drink



Avenida de Las Cortes  
Valencianas, 59



900 208 308

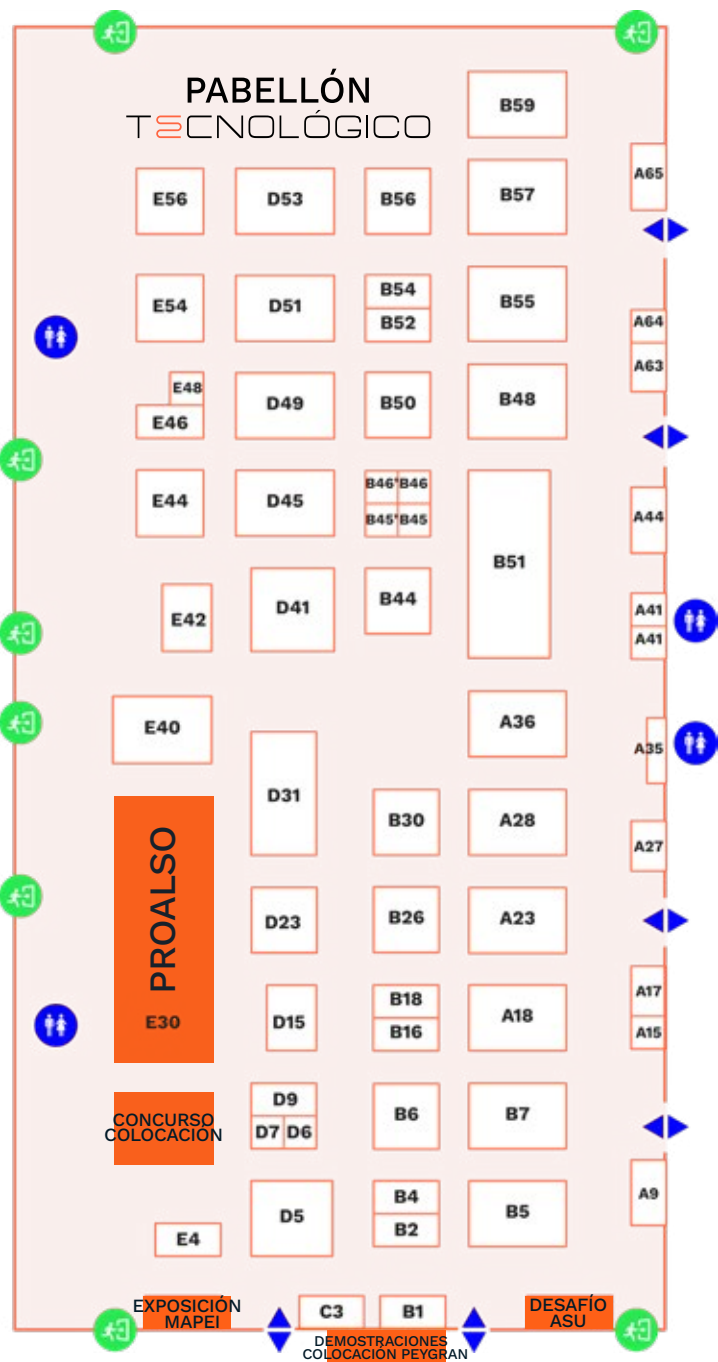
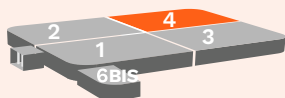

Expositor / Exhibitor Marca / Brand	Pab. Pav.	
7C TOOLS	P4	A18
AKEMI SPAIN	P4	E4
ALIPLAST IBERIA SLU	P4	B54
AMBERGER KAOLINWERKE	P4	A63
ANERR	P4	D7
ARMADA GROUPE INSAAT TURIZM GIDA SAN.	P4	B16
ARTTROS LEVELING SYSTEMS	P4	D5
ASEBEC / ITC	P4	B59
ASOC. FABRICANTES DE LADRILLOS Y TEJAS CV	P4	A41
BARRAGANES GRUPO	P4	B55
C.S.H. CABANES SL	P4	E48
CAMI DEPIRAZIONI GREEN TECHNOLOGY SRL	P4	A41
CERTECH SPAIN SL	P4	B57
CIPASI	P4	B45
CORBARIO MINERAIS INDUSTRIAIS	P4	E54
CORTAG INDUSTRIA E COMERCIO LTDA	P4	A28
CRÉDITO Y CAUCIÓN	P4	A27
DACHSER	P4	B52
DAKOTA	P4	B18
DAL PRETE	P4	E46
DAS TECH SOLUTIONS SLU	P4	D49
DONATONI MACCHINE	P4	D53
EMCO SPAIN	P4	D6
ETERNO IVICA	P4	A18
FABER IBÉRICA SL	P4	D9
FERRARI & CIGARINI SRL	P4	D45
FILA - SURFACE CARE SOLUTIONS	P4	D23
FORANKRA ESPAÑA	P4	A64
FORO	P4	B56
GHELFI SRL	P4	B4
GRUPO COGULLADA	P4	B51
GUNSEN BUILDING PRODUCTS	P4	D15
HOSOKAWA ALPINE GROUP	P4	B45'
IBERTRONIX INFRARED & VISION SL	P4	B46'
ICF & WELKO SPA	P4	B48
INDUSTRIAS PEYGRAN SL	P4	B23



**Expositor / Exhibitor**  
Marca / Brand

**Pab.**  
Pav.



Expositor / Exhibitor Marca / Brand	Pab.	Pav.
INGENEO EQUIPOS INDUSTRIALES SL	P4	B50
INTERGLOBO	P4	A65
IRIDOI	P4	B6
IZOMAK YAPI ALUMINIUM AND STAINLESS	P4	A17
LEICA GEOSYSTEMS PART OF HEXAGON	P4	C3
MAINCER SL	P4	A36
MAPEI	P4	D41
MCS PORTUGAL	P4	E44
MOLDE AZUL	P4	D51
MONTOLIT HERRAMIENTAS PROFESIONALES	P4	B26
NOGOSA IBERICA SLU	P4	B7
ODEM	P4	B5
PORTCASTELLÓ	P4	E56
PROALSO, ASOCIACIÓN PROF. ALICATADORES	P4	E30
PRODIM INTERNATIONAL BV	P4	B46
PROFILBER	P4	B1
PROFILITEC	P4	B2
PRUSSIANI ENGINEERING	P4	B44
RAIMONDI SPA	P4	A9
RESACRIL SL	P4	A63
RUBI GROUP	P4	D31
SACMI	P4	E40
SAVINO DEL BENE SL	P4	A44
SIGMADIAMANT SL	P4	E42
SUIMCO	P4	A18
SWISSPOR BOARD	P4	A35
TOMECANIC - CONSTOOLS	P4	B30

# FeriaHábitat València

29 sep - 2 oct. 2025

Coincidiendo con  
Coinciding with

TEXTILHOGAR HOME TEXTILES PREMIUM



FERIA VALENCIA



# PROGRAMA DE ACTIVIDADES

## Agenda Programme

## Actividades permanentes Permanent Activities

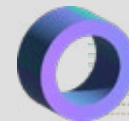

### PREMIOS CEVISAMA LAB 2025 / 2025 CEVISAMA LAB AWARDS

Exposición de los proyectos premiados en el Certamen de Talentos Emergentes. Hotel Cevisama, Pabellón 3, Nivel 2.

Exhibition of the winning projects in the Emerging Talents Competition, Cevisama Hotel, Pavilion 3, Level 2.

### ASCER, CAMPAÑA “RESPETO” / ASCER, “RESPECT” CAMPAIGN

Acceso principal a feria.

Main entrance to the fair.

### PROALSO

XXIII Encuentro de colocadores. Pabellón 4, Nivel 2.

XXIII Placemakers Meeting. Pavilion 4, Level 2.

### EXCO. XXXIV SALÓN TECNOLÓGICO DE LA CONSTRUCCIÓN / EXCO XXXIV CONSTRUCTION TECHNOLOGY EXHIBITION

Foro Norte, Salón de Actos.  
Miércoles 26, Jueves 27 y viernes 28 de febrero.

North Forum, Conference Hall.  
Wednesday, February 26th; Thursday, February 27th; and Friday, February 28th

### DEGUSTACIÓN PAELLA / PAELLA TASTING

Distribuidor, entre los pabellones 3 y 4. De lunes a jueves.

Distributor area, between pavilions 3 and 4. From Monday to Thursday.

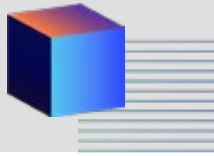

**Lunes, 24 Feb / Monday, 24th Feb**

10:30 h.

**Inauguración Oficial.** Foro Centro.

**Official Inauguration.** Central Forum.

11:00 h.

Encuentro con la prensa **Héctor Ruiz-Velázquez** y visita guiada a Hotel Cevisama 2025. Hotel Cevisama, Pabellón 3, Nivel 2.

Press meeting with **Héctor Ruiz-Velázquez** and guided tour of Hotel Cevisama 2025. Cevisama Hotel, Pavilion 3, Level 2.

**FORO INTERIORISMO, ARQUITECTURA Y CONTRACT / INTERIOR DESIGN, ARCHITECTURE AND CONTRACT FORUM**

Patrocinado por la Vicepresidencia Primera y Conselleria de Servicios Sociales, Igualdad y Vivienda

Sponsored by the First Vice Presidency and the Department of Social Services, Equality, and Housing.

10:30 h. - 12:00 h. **THE NEW ARCHITECTONICS**

Hospitality. Cómo garantizar un crecimiento sostenible. Diseño y materialidad. Hotel Cevisama, Pabellón 3, Nivel 2.

Hospitality: How to Ensure Sustainable Growth. Design and Materiality. Hotel Cevisama, Pavilion 3, Level 2.

**Presentación de proyectos / Project Presentations:**

- Raquel Sanjuan Estudio, **Raquel Sanjuan.**
- Medrano + Saez, **Chema Medrano.**

**Mesa redonda / Round table:**

- Kover Siglo XXI, **Alberto Moldon.**
- Calallarga, **Vicente Gregori.**
- Intelier. Hoteles & Suites, **Iker Llano.**
- FS Francisco Segarra Furniture Vintage, **Francisco Segarra.**

**Moderador / Moderator:** PHG, **Ivar Yuste.**

12:00 h. - 13:30 h. **THE NEW ARCHITECTONICS**

La importancia de la industrialización en el ámbito del Hospitality. Nuevos escenarios: Residencias, coliving. Hotel Cevisama, Pabellón 3, Nivel 2.

The Importance of Industrialization in the Hospitality Sector. New Scenarios: Residences, Coliving. Hotel Cevisama, Pavilion 3, Level 2.

**Presentación de proyectos / Project Presentations:**

- Alfaro-Manrique Atelier, **Emili Manrique.**
- TdB Arquitectura SLP, **Juan Núñez.**

**Mesa redonda / Round table:**

- TM Grupo Inmobiliario, **Jaime Carlos Alonso.**
- Wes Panel, **Ángel Alfocea.**
- XIOB Grup, **Juanvi Pallares.**
- Actia Tech, **Felipe Vieties.**

**Moderador / Moderator:** Universidad de Navarra, **Pedro J. López.**

17:00 h.

Entrega **Premios Alfa de Oro.** Hotel Cevisama, Pabellón 3, Nivel 2.

**Alfa de Oro Awards Ceremony.** Cevisama Hotel, Pavilion 3, Level 2.

**Martes, 25 Feb / Tuesday, 25th Feb**

10:00 h. - 13:00h.

**Rehabiforum ANERR:** La EPBD, retos y oportunidades de la nueva directiva europea. Casos de éxito de empresas. Sala Joaquín Rodrigo.

**Rehabiforum ANERR:** The EPBD, challenges and opportunities of the new European directive. Success stories from companies. Joaquín Rodrigo Hall.

10:15 h.

Entrega **Premios Stands Cevisama. Homenaje al interiorista Antonio Salinas.** Hotel Cevisama, Pabellón 3, Nivel 2.

**Cevisama Stand Award Ceremony. A tribute to interior designer Antonio Salinas.** Cevisama Hotel, Pavilion 3, Level 2.

10:30 h.

Conferencia prensa internacional **ASCER.** Entrega Premios Cerámica. Centro de Eventos, Auditorio 3A.

**ASCER International Press Conference. Ceramic Awards Ceremony.** Events Centre, Auditorium 3A.

**FORO INTERIORISMO, ARQUITECTURA Y CONTRACT / INTERIOR DESIGN, ARCHITECTURE AND CONTRACT FORUM**

Patrocinado por la Vicepresidencia Primera y Conselleria de Servicios Sociales, Igualdad y Vivienda

Sponsored by the First Vice Presidency and the Department of Social Services, Equality, and Housing.

11:00 h. **INTERIORISMO / INTERIOR DESIGN**

Conferencia **Javier Jiménez, Studio Animal.** Hotel Cevisama, Pabellón 3, Nivel 2.

Lecture by **Javier Jiménez, Studio Animal.** Cevisama Hotel, Pavilion 3, Level 2.

12:30 h. **INTERIORISMO / INTERIOR DESIGN**

Conferencia **Leyre Ortuño y Juan Luis Medina, MIL Studios.** Hotel Cevisama, Pabellón 3, Nivel 2.

Lecture by **Leyre Ortuño y Juan Luis Medina, MIL Studios.** Cevisama Hotel, Pavilion 3, Level 2.

16:00 h. **ARQUITECTURA / ARCHITECTURE**

Conferencia **Jaime Sanahuja.** Hotel Cevisama, Pabellón 3, Nivel 2.

Lecture by **Jaime Sanahuja.** Cevisama Hotel, Pavilion 3, Level 2.

17:00 h. **ARQUITECTURA / ARCHITECTURE**

DANA 2024 - Emergencia habitacional. Identificación y metodología de daños en edificación. Hotel Cevisama, Pabellón 3, Nivel 2.

DANA 2024 - National Emergency. Identification and Damage Assessment Methodology in Buildings. Hotel Cevisama, Pavilion 3, Level 2.

**Conferencia impartida por / Conference presented by:**

- **Pablo Peñín**, secretario del Colegio Territorial de Arquitectos de Valencia.
- **Sergio Cebrián**, arquitecto municipal de Paiporta.

19:00 h. - 21:30h.

Entrega **Premios a la Distribución de Cerámica y Baño 2025.** Ciudad de las Artes y las Ciencias, Valencia. (Sala Calle Mayor, 1ª Planta Museo Príncipe Felipe). \*Acceso con invitación.

**Ceramic and Bathroom distribution Awards 2025 Ceremony.** Ciudad de las Artes y las Ciencias, Valencia. (Sala Calle Mayor, 1ª Planta Museo Príncipe Felipe). \*Access by invitation only.

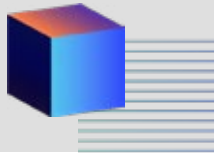

**Miércoles, 26 Feb / Wednesday, 26th Feb**

**10:00 h. - 11:00h.**

**AIDIMME Innovación I+D.** Los especialistas del Instituto hablarán sobre ensayos, certificaciones de producto, y normativas, y su repercusión en la internacionalización (ASEBAN)  
Hotel Cevisama, Pabellón 3, Nivel 2.

**AIDIMME Innovation R&D.** The Institute's specialists will discuss testing, product certifications, and regulations, as well as their impact on internationalization. (ASEBAN)  
Cevisama Hotel, Pavilion 3, Level 2.

**10:00 h. - 11:00h.**

**Instituto de Tecnología Cerámica ITC.** La disrupción que transformará la cerámica "Tres tecnologías, un mismo objetivo: revolucionar la industria cerámica". **Stand de ASEBEC.** Pabellón 4, stand B59

**Institute of Ceramic Technology (ITC).** The disruption that will transform ceramics. "Three technologies, one goal: Revolutionizing the ceramic industry." **Stand de ASEBEC.** Pavilion 4, stand B59

**12:00 h.**

**Día del Ladrillo Cevisama 2025.**  
Sala Joaquín Rodrigo.

**Brick Day Cevisama 2025.**  
Joaquín Rodrigo Hall.

**12:00 h.**

Encuentro con la comunidad portuaria y presentación del informe por parte del presidente de la Autoridad Portuaria de Castellón, **Rubén Ibáñez.** Pabellón 4, Stand E56.

Meeting with the port community and presentation of the report by the president of the Port Authority of Castellón, **Rubén Ibáñez.** Pavilion 4, Stand E56.

**FORO INTERIORISMO, ARQUITECTURA Y CONTRACT / INTERIOR DESIGN, ARCHITECTURE AND CONTRACT FORUM**

Patrocinado por la Vicepresidencia Primera y Conselleria de Servicios Sociales, Igualdad y Vivienda

Sponsored by the First Vice Presidency and the Department of Social Services, Equality, and Housing.

**11:00 h. INTERIORISMO / INTERIOR DESIGN**

Conferencia **Natali Canas, El Equipo Creativo.**  
Hotel Cevisama, Pabellón 3, Nivel 2.

Lecture by **Natali Canas, El Equipo Creativo.**  
Cevisama Hotel, Pavilion 3, Level 2.

**12:30 h. INTERIORISMO / INTERIOR DESIGN**

Conferencia **Eva Prego y Cutu Mazuelos, Stone Designs.**  
Hotel Cevisama, Pabellón 3, Nivel 2.

Lecture by **Eva Prego y Cutu Mazuelos, Stone Designs.**  
Cevisama Hotel, Pavilion 3, Level 2.

**16:00 h. INTERIORISMO / INTERIOR DESIGN**

Conferencia **Amparo Taylor.**  
Hotel Cevisama, Pabellón 3, Nivel 2.

Lecture by **Amparo Taylor.**  
Cevisama Hotel, Pavilion 3, Level 2.

**17:00 h.**

"Transformando la experiencia hotelera, el baño como elemento clave".  
**Manel Lozano,** Country Manager de ramonsoler Group en España y Portugal.  
Hotel Cevisama, Pabellón 3, Nivel 2.

"Transforming the hotel experience, the bathroom as a key element."  
**Manel Lozano,** Country Manager of ramonsoler Group in Spain and Portugal.  
Cevisama Hotel, Pavilion 3, Level 2.

**Jueves, 27 Feb / Thursday, 27th Feb**

**FORO INTERIORISMO, ARQUITECTURA Y CONTRACT / INTERIOR DESIGN, ARCHITECTURE AND CONTRACT FORUM**

Patrocinado por la Vicepresidencia Primera y Conselleria de Servicios Sociales, Igualdad y Vivienda

Sponsored by the First Vice Presidency and the Department of Social Services, Equality, and Housing.

**10:30 h. - 12:00 h. THE NEW ARCHITECTONICS**

Cambio de paradigma en el sector hotelero, educativo, asistencial y futuro vertical.  
Hotel Cevisama, Pabellón 3, Nivel 2.

Paradigm Shift in the Hospitality, Educational, Healthcare, and Vertical Future Sectors.  
Hotel Cevisama, Pavilion 3, Level 2.

**Presentación de proyectos / Project Presentations:**

- Adoras, Atelier de Arquitectura, **Jesús Gallego.**
- Morph Estudio, **César Frías.**

**Mesa redonda / Round table:**

- Adriana Nicolau, **Adriana Nicolau.**
- CIDON Interior Design & Contract, **Alba Vila.**
- Soho Boutique Hoteles, **Pablo Herrera de la Muela.**
- Findnido, **Alejandro González.**
- AEDAS HOME, **José María Quirós.**

**Modera / Moderator:** GAT Gestión, **Ramón Garayar.**

**12:00 h. - 13:30 h. THE NEW ARCHITECTONICS**

Industrialización y modulación. Nuevos espacios para el desarrollo.  
Hotel Cevisama, Pabellón 3, Nivel 2.

Industrialization and Modulation: New Spaces for Development.  
Hotel Cevisama, Pavilion 3, Level 2.

**Presentación de proyectos / Project Presentations**

- GVI Internacional, **Vicenç Morant.**
- Rafael de la Hoz, **Javier Lallana.**

**Mesa redonda / Round table:**

- Hotel Boutique Hort de Naí, **Lucía González.**
- Qilak, **Juan Antonio Gómez.**
- Woodvile, **Fernando Oiza.**
- Room 2030, **Sergio Baragaño.**
- Viraje Arquitectura, **Jesús Herranz.**

**Modera / Moderator:** Zdenka Lara Interiorismo, **Zdenka Lara.**

**12:00 h.**

Presentación Valencia Port. Presenta presidente del puerto de Valencia Sra. **Dª Mar Chao López.**  
Distribuidor Central.

Presentation of Valencia Port. Presented by the President of the Port of Valencia, **Mrs. Mar Chao López.**  
Central Distributor.

## Actividades diarias

### Daily Activities

## Programa de conferencias EXCO'25

XXXIX Salón Tecnológico de la construcción

### Lectures Schedule EXCO'25

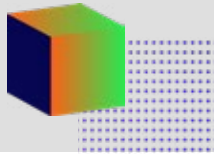

### Jueves, 27 Feb / Thursday, 27th Feb

13:00 h.

Clausura **Encuentro Estudiantes Colocación Cerámica**.

Zona Proalso. Nivel 2 Pabellón 3.

Closing **Ceremony of the Student Meeting on Ceramic Installation**.

Proalso Zone. Level 2, Pavilion 3.

16:00 h. - 18:00 h. **STONE GALLERY**

“Aplicaciones de Piedra Natural en Arquitectura”.

Hotel Cevisama, Pabellón 3, Nivel 2.

“Applications of Natural Stone in Architecture”.

Hotel Cevisama, Pavilion 3, Level 2.

- **Estudio VVV. Ciro Vidal e Ivo Vidal** - Biblioteca Municipal, Pego
- **Estudio VVV. Ciro Vidal e Ivo Vidal** - Rehabilitación energética barrio de la Sang, Alcoy
- **Pablo Muñoz Payá Arquitectos** - Pabellón en la Pedrera, Monóvar
- **Ánima Arquitectura. Cueva Santa Morro** - Castillo Palacio de Beatriz de Borja, Castellnovo
- **Decanía Arquitectura. Anna delcampo** - Molí La Vila, Vila-real
- **Virtuarch Studio. Vicente Dualde, Carme Carbó** - CEIP Verge de Vallivana, Morella
- **Mentrestan Arquitectura cooperativa. Irene Civera, Jorge Navarro y José Sambartolomé** - Casa Paquí, Pobra de Vallbona

### Viernes, 28 Feb / Viernes, 28th Feb

#### FORO INTERIORISMO, ARQUITECTURA Y CONTRACT / INTERIOR DESIGN, ARCHITECTURE AND CONTRACT FORUM

Patrocinado por la Vicepresidencia  
Primera y Consellería de Servicios  
Sociales, Igualdad y Vivienda

Sponsored by the First Vice Presidency  
and the Department of Social Services,  
Equality, and Housing.

10:00 h. - 12:00 h. **THE NEW ARCHITECTONICS**

Arquitectura y diseño. Elementos clave  
para satisfacción del cliente final.

Hotel Cevisama, Pabellón 3, Nivel 2.

Architecture and Design: Key Elements  
for Final Customer Satisfaction.

Hotel Cevisama, Pavilion 3, Level 2.

#### Presentación de proyectos / Project Presentations:

- Arqueha, **Carlos Blanco**.
- Inhaus, **Rubén Navarro**.
- Eseeisa, **Irene Soriano**.

#### Mesa redonda / Round table:

- Casual Hoteles, **Juan Carlos Sanjuán**.
- Aecom, **Alfonso López**.
- Sweet Hoteles, **Luis Fernández**.
- Zenova, **Jaime González**.

**Modera / Moderator:** Main Form, **Guillermo Mocholí**.

13:00 h.

Entrega **Premios CevisamaLab 2025**.

Hotel Cevisama, Pabellón 3, Nivel 2.

**2025 CevisamaLab Awards Ceremony**.

Cevisama Hotel, Pavilion 3, Level 2.

\*Todas las actividades de EXCO se  
realizarán en Feria Valencia, Foro  
Norte, Salón de Actos.

\*All EXCO activities will take place  
in the Feria Valencia, North Forum,  
Conference Hall.

### Miércoles, 26 Feb / Wednesday, 26th Feb

9:00 h. - 9:20h.

Bienvenida EXCO'25, acto de  
inauguración, **Fernando José Cos-  
Gayón López y José Ramón Albiol  
Ibáñez**.

Welcome to EXCO'25 opening  
Ceremony, **Fernando José Cos-Gayón  
López and José Ramón Albiol Ibáñez**.

9:30 h. - 9:50h.

“Viviendas Industrializadas en Chile:  
Ahorro, calidad y sustentabilidad”  
(Chile), **Sebastián Donoso Lüer**.

“Industrialized Housing in Chile:  
Savings, quality and sustainability”  
(Chile), **Sebastián Donoso Lüer**.

10:00 h. - 10:20h.

“Impresión 3D de hormigón y  
tecnología de construcción inteligente  
aditiva: diseño de materiales,  
fabricación digital y aplicaciones de  
ingeniería” (China), **Sun Xiaoyan**.

“3D Printing concrete and additive  
intelligent construction technology:  
Material design, digital fabrication and  
engineering application” (China), **Sun  
Xiaoyan**.

10:40 h. - 11:00h.

“Propuesta de actuaciones para la  
creación de una red de control de  
niveles freáticos en el municipio de  
Bétera” (España), **Elía Verdevío  
Escribá, Lucía Belenguer Espinosa y Javier  
Rodrigo Ilarri**.

“Proposal for actions for the  
creation of a network for monitoring  
groundwater levels in the municipality  
of Bétera” (Spain), **Elía Verdevío  
Escribá, Lucía Belenguer Espinosa and  
Javier Rodrigo Ilarri**.

11:10 h. - 11:30h.

“¿Podemos predecir tempranamente  
el futuro de un proyecto? ¿Y hacer  
algo para construir un mejor futuro?”  
(Chile), **Luis Fernando Alarcon  
Cardenas**.

“Can we predict the future of a project  
early on? and do something to build  
a better future” (Chile), **Luis Fernando  
Alarcon Cardenas**.

11:40 h. - 12:00h.

“Grupo Avintia: Caso de estudio Ávita”  
(España), **José Ignacio Esteban Gil**,  
Director General de Ávita.

“Avintia Group: Case of study Ávita”  
(Spain), **José Ignacio Esteban Gil**,  
Director General de Ávita.

12:20 h. - 12:40h.

“Grupo Ferrol: Distintos combustibles  
para el mercado de la climatización”  
(España), **Víctor M. García Gil**.

“Grupo Ferrol: Different fuels for the  
air conditioning market” (Spain), **Víctor  
M. García Gil**.

12:50 h. - 13:10h.

“La IA Generativa en la enseñanza de  
Diseño Arquitectónico: ¿revolución  
creativa con algoritmos?” (Uruguay),  
**Gastón Boero Falcini**.

“Generative AI in Architectural Design  
teaching: A creative revolution with  
algorithms” (Uruguay), **Gastón Boero  
Falcini**.

## Programa de conferencias EXCO'25

XXXIX Salón Tecnológico de la construcción

Lectures Schedule EXCO'25

\*Todas las actividades de EXCO se realizarán en Feria Valencia, Foro Norte, Salón de Actos.

\*All EXCO activities will take place in the Feria Valencia, North Forum, Auditorium.

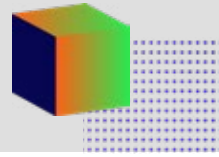

## Programa de conferencias EXCO'25

XXXIX Salón Tecnológico de la construcción

Lectures Schedule EXCO'25

### Miércoles, 26 Feb / Wednesday, 26th Feb

13:20 h. - 13:40h.

“COAT Valencia: El valor del Arquitecto Técnico en la empresa” (España), **Borja Nebot Huerta y José Vicente Espí Navarro.**

“COAT Valencia: The value of the Building Engineer in the company” (Spain), **Borja Nebot Huerta y José Vicente Espí Navarro.**

15:40 h. - 16:00h.

“Dirección y gestión de proyectos en entornos BIM” (España), **Begoña Fuentes Giner.**

“Project Management in BIM environments” (Spain), **Begoña Fuentes Giner.**

16:10 h. - 16:30h.

“Planificación territorial con Big Data: Predicción de asentamientos informales en Ecuador” (Ecuador), **Miriam Guillén Vivas.**

“Territorial planning with Big Data: Prediction of informal settlements in Ecuador” (Ecuador), **Miriam Guillén Vivas.**

16:40 h. - 17:00h.

“Producción y suministro de ACS en Volúmenes de Control Abiertos en Régimen Dinámico” (España), **Antonio Romero Sedó y Paloma Arrué Burillo.**

“Production and supply of ACS in Open Control Volumes in Dynamic Regime” (Spain), **Antonio Romero Sedó and Paloma Arrué Burillo.**

17:10 h. - 17:30h.

“Construcción industrializada: De la teoría a la práctica” (España), **Milagro Iborra Lucas.**

“Industrialized construction: From theory to practice” (Spain), **Milagro Iborra Lucas.**

### Jueves, 27 Feb / Thursday, 27th Feb

9:00 h. - 9:20h.

“Niveles de competencia en el diseño de edificios en Finlandia según la nueva Ley de Construcción y su impacto en el plan de estudios de la Universidad de Ciencias Aplicadas de Turku” (Finlandia), **Tapio Keiramo.**

“Competence levels of building design in Finland according to the new construction act and their impact on the curriculum at Turku University of Applied Sciences” (Finland), **Tapio Keiramo.**

9:30 h. - 9:50h.

“Gemelo digital en la gestión de activos” (Italia), **Fulvio Recceconi.**

“Digital Twin in Asset Management” (Italy), **Fulvio Recceconi.**

### Jueves, 27 Feb / Thursday, 27th Feb

10:00 h. - 10:20h.

“La contribución de la impresión 3D al consumo y producción responsable (ODS 12)” (Dubai), **Salman Pervaiz.**

“3D Printing’s contribution to responsible consumption and production (SDG12)” (Dubai), **Salman Pervaiz.**

10:40 h. - 11:00h.

“ITERCON: Planificación inteligente de proyectos eficientes y tecnológicamente avanzados” (España), **Teresa Pous Chiari.**

“ITERCON: Smart planning of efficient and technologically advanced projects” (Spain), **Teresa Pous Chiari.**

11:10 h. - 11:30h.

“Métodos modernos de construcción en Chile: Tecnologías y metodologías emergentes que revolucionan la industria” (Chile), **Carolina Briones Lazo.**

“Modern methods of construction in Chile: Emerging technologies and methodologies revolutionizing the industry” (Chile), **Carolina Briones Lazo.**

11:40 h. - 12:00h.

“Ajuste de un enfoque centrado en el usuario para evaluar el confort visual” (Italia), **Tiziana Poli.**

“Tuning a User-centred approach to evaluate visual comfort” (Italy), **Tiziana Poli.**

12:20 h. - 12:40h.

“Investigación sobre el impacto de la eficiencia laboral en espacios de oficina basados en la percepción visual y olfativa” (China), **Tao Yiqi.**

“Research on the impact of work efficiency at office space based on visual and olfactory perception” (China), **Tao Yiqi.**

12:50 h. - 13:10h.

“Diseño de estructuras de hormigón armado basado en inteligencia artificial” (Polonia), **Patryk Ziótkowski.**

“Artificial intelligence-based design of reinforced concrete structures” (Poland), **Patryk Ziótkowski.**

13:20 h. - 13:40h.

“Planificación de infraestructuras: Planteamiento de diseño de drenajes y complejidad de soluciones locales” (Alemania), **Sonia Almagro Pastor.**

“Infrastructure planning: Drainage design approach and complexity of local solutions” (Germany), **Sonia Almagro Pastor.**

15:40 h. - 17:40h.

Visita guiada Cevisama.

Cevisama Guided Tour.



## Programa de conferencias EXCO'25

XXXIX Salón Tecnológico de la construcción

### Lectures Schedule EXCO'25

\*Todas las actividades de EXCO se realizarán en Feria Valencia, Foro Norte, Salón de Actos.

\*All EXCO activities will take place in the Feria Valencia, North Forum, Auditorium.

Viernes, 28 Feb / Friday, 28th Feb

9:00 h. - 10:20h.

#### CATEDRA OBSERVATORIO DE LA VIVIENDA: MESA REDONDA

"De los datos a la acción: Propuestas para abordar la emergencia habitacional" (España), **Fernando José Cos-Gayón López.**

#### CHAIR OF HOUSING OBSERVATORY: ROUND TABLE

"From Data to action: Proposals to address the housing emergency" (Spain), **Fernando José Cos-Gayón López.**

10:40 h. - 11:00h.

"La educación superior en arquitectura y el desarrollo ecológico en China: la Universidad de Arquitectura y Tecnología de XI'AN y sus especialidades" (China), **Wilson Youqun Wang.**

"China's Architecture higher education and green development: XI'AN University of Architecture and Technology and its specialities" (China), **Wilson Youqun Wang.**

11:10 h. - 11:30h.

"Clásica Urbana: Implantación de LEAN en construcción residencial" (España), **Javier Marchesi Alcober.**

"Implementation of LEAN residential construction" (Spain), **Javier Marchesi Alcober.**

11:40 h. - 12:00h.

"Grupo Bertolín: Optimización de sistemas constructivos y mejora de la productividad" (España), **José Vicente Espí Navarro.**

"Bertolin Group: Optimization of construction systems and improvement of productivity" (Spain), **José Vicente Espí Navarro.**

12:20 h. - 12:40h.

"Un diseño experimental orientado al ser humano" (China), **Stephen Lau.**

"An experimental Human-Oriented design" (China), **Stephen Lau.**

12:50 h. - 13:10h.

"Evaluación de la vida útil de estructuras de hormigón armado mediante sensores" (España), **José Manuel Gandía Romero.**

"Lifetime assessment of reinforced concrete structures using sensors" (Spain), **José Manuel Gandía Romero.**

13:20 h. - 13:40h.

"Práctica profesional en el diseño de una ciudad sostenible, habitable y compacta: estudio de caso en Hong Kong" (China), **Sunnie Lau.**

"Professional practice on designing a sustainable, liveable compact city - Case study of Hong Kong" (China), **Sunnie Lau.**

13:50 h.

Clausura. **José Ramón Albiol Ibáñez.**

Closing Event. **José Ramón Albiol Ibáñez.**

# HOTEL CEVISAMA

PABELLÓN / PAVILION 3

## Colaboradores / Collaborators

apegrupo

asm  
A S M T A P S  
WATER SOUL

coycama

CRISTÁCER

decocer

DECOSAN

Bath design

exagres  
TECHNICAL SOLUTIONS

GAYAFORES

GENEXIA  
LUBRICA TU BARRIO

hidronatur  
by Plasvina

Keraben  
CERAMICS SPA

poalgi

ramonsoler.

REALONDA  
CERAMICA

stn  
CERAMICA

undefasa  
always ceramics

VIVES

VOGO  
SMART EVOLUTION

CVSMA 25

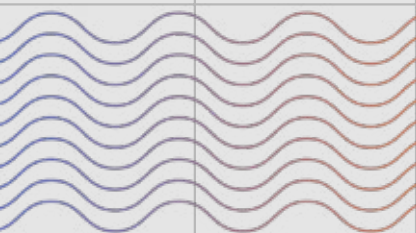

**24 - 28 FEB**  
**VALÉNCIA - SPAIN**

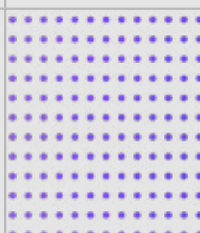
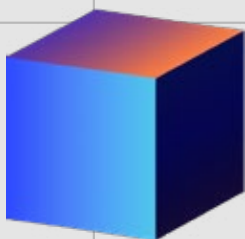

#Cevisama25 [cevisama.com](http://cevisama.com)



FERIA VALENCIA